

Education

Specification Guide to Floors, Walls & Accessories

gerflor.co.uk
gerflor.ie
gradus.com



Gerflor[®]

GRADUS



**A NEW LEVEL
OF INNOVATION,
QUALITY, SERVICE
& TEAMWORK**



**NEXT DAY SERVICE
PRODUCT EXPERTISE
WARRANTY
SUSTAINABILITY**



**FLOOR COVERING
STAIR EDGINGS
FLOOR TRIMS
MATTING
WALL PROTECTION
LIGHTING**

Contents

Gerflor | Gradus

The Education Specialists	2
Gerflor Gradus - Services	4
Comprehensive Education Solutions Map	6

Education Areas

Entrance & Reception Areas	8
Corridors & Hallways	10
Sports Halls	12
Classrooms	14
Libraries	16
Dining & Assembly Halls	17
Kitchens	18
WC's	19
Mainframe Rooms	20
Head Teachers Office	21
Computer Rooms	22
Outdoor Sports Areas	23
Staff Rooms	24
Wetrooms & Shower Rooms	25
Laboratories	26
Changing Rooms	27
Case Studies	28
Innovation, Service & Design	30
Our Commitments for a Sustainable Future	32

Disclaimers

Due to printing limitations there may be variations between the colours of the actual flooring and images shown in this document. The technical information contained in this brochure is subject to change at any time due to products being subject to continuous improvement processes. Please check latest technical information on our websites www.gerflor.co.uk & www.gradus.com or with a sales advisor prior to ordering.

Gerflor & Gradus – The Education Specialists

With over 100 years of combined experience in the education sector, together we have built an unrivalled reputation for quality and service.

The **Gerflor group** is well known as a credible and valued supplier of complete flooring solutions designed specifically for the education market. The constraints of hygiene, slip resistance and acoustic qualities are part of mandatory characteristics for this sector.

Our expertise allows us to offer numerous flooring products suitable for all areas of an education facility. Whilst maintaining the technical performance and the design aspect of our floorcoverings, we manufacture our ranges with the environment in mind as well as the health and wellbeing of end-users. We have recognised brands ideal for education facilities including our Mipolam, DLW, Taralay, Taraflex®, Tarasafe, Creation and Gradus carpet ranges.

Gradus is a UK manufacturer of contract interior solutions, these include stair edgings, floor trims, barrier matting, wall protection and lighting. As the leading UK manufacturer of these solutions, we support our customer's projects to provide safe, accessible, attractive and inclusive environments for all users. Gradus controls the design of products from initial concept through to final manufacture, including specialist CAD design and the manufacture of tooling.

This ensures that quality is maintained and provides customers with an efficient, flexible, and fast service. We also offer site survey, project management and installation services for our wall protection, entrance matting and lighting products.



Many years of understanding the Education sector has shown us the key considerations required to deliver a successful contract interior project...



Welcoming & attractive environments

Gerflor and Gradus offer a wide range of design driven products for all areas in an educational facility, perfect for creating an inspiring, engaging and unique space. Choose from a large range of designs across our flooring and wall cladding products, or for something truly individual use our bespoke Myfloor and printed wall cladding services.



Multi-use areas

Designing multi-functional areas can play a significant role in the utilisation and flexibility of a space. Taraflex Multi-use sports flooring is suitable for sports halls that also act as a dining/assembly hall. Corridors act as both circulation and social spaces so products such as SureProtect Endure wall cladding, with its bright colours can create a motivating environment for pupils as well as protecting the walls from scuffs & scrapes.



Reducing the risk of slips, trips and falls

According to the Health and Safety Executive (HSE), slips and trips account for over a third of all major injuries in buildings. Gerflor flooring has been developed to offer excellent slip resistance. Gradus' uniquely designed stair edgings also play a crucial role in preventing slips, trips and falls on stairs.



Reducing life cycle costs

Education facilities are highly active environments with frequent movement of both equipment and people, necessitating the use of durable and easy-to-maintain materials. To address this need, Gerflor offers flooring products made from high quality materials. Additionally, Gradus barrier matting and wall protection can play a significant role in reducing a buildings life cycle costs by decreasing maintenance and repair expenses.



Sustainability

Gerflor and Gradus offer a range of environmentally friendly flooring, wall covering, and accessory solutions that incorporate recycled materials, are recyclable at the end of their life, and are both durable and low maintenance. These products and sustainable initiatives play a crucial role in supporting carbon reduction in the construction sector.

Gerflor & Gradus Services

Technical and Specification Support Specialists

Our dedicated education specialists can assist you with all your specification needs. Whether it's a refurbishment project or new build, we have the expertise and innovations to create your ideal interior scheme. We work together to propose the optimum solution for the clients' needs, utilising the most appropriate safe, durable and sustainable solutions for the specific applications. We don't stop at just providing specification advice, we can also provide a free site survey where we will visit, assess and audit the facility and make suggestions on improvements to future proof the building interiors.



The Technical Support team is available to offer advice on the specification and installation of products, including guidance surrounding the latest building standards and legislation. Be rest assured that Gerflor & Gradus have a world-class pedigree of products that are tried and trusted to deliver every time. All backed up by a network of technical, specification and customer support teams.

Sampling Support Services

We offer a free sample service for all our clients from product overview binders, loose samples to supporting literature. For something bespoke like mood boards or test material, contact us and we will aim to supply the sample for your required need. To request a sample, literature, or anything else call 01625 428922 or email contractuk@gerflor.com or imail@gradus.com.

Local stock

We stock our best-selling product ranges locally in the UK. Our warehousing and distribution facilities in Winsford and Macclesfield offer a broad range of in-depth stock to provide an enhanced service level. Essential when time is of the essence and our customers need innovative products and fast delivery for essential quick turnaround projects. Speak to our education specialists for stock availability or further information.



Specification Documents and BIM Objects

NBS provides access to a single source of product information and BIM objects for Gerflor & Gradus products. NBS Source provides an additional level of enhanced product data in a consistent, structured format that will integrate seamlessly into your project workflow.

Education Lunch & Learn Sessions

Our education specification experts are available to help with developing knowledge surrounding Flooring, Barrier Matting, Wall Protection, LED Lighting, Stair Edgings and Floor Trims.

For something less formal than a traditional CPD, a Lunch & Learn session with our hospitality specialists can be arranged at a time and date to suit you and people can drop in as they wish to discuss our products generally or address specific project requirements.

To book a Lunch & Learn session, contact our Technical Support team on 01625 428922, email contractuk@gerflor.com or imail@gradus.com.



CPD's and Training

As members of RIBA CPD Providers Network, we offer a full range of RIBA assessed and approved CPD seminars covering: Vinyl Flooring, Sports Flooring, Matting, Wall Protection, Stair Edgings and industry specific CPD's such as Healthcare and Industry.

To book a CPD Seminar, contact our Technical Support team on 01625 428922, email: contractuk@gerflor.com or imail@gradus.com.

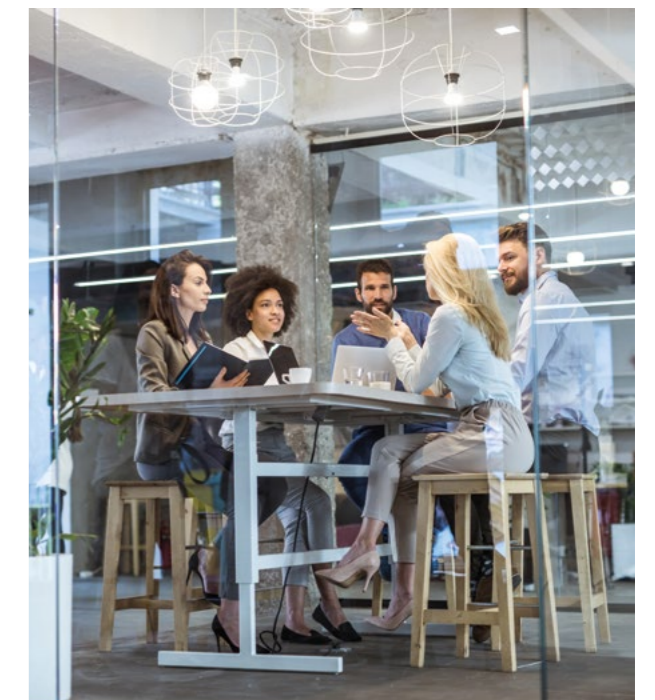

Accreditations and Certifications

Gerflor



Gradus



Comprehensive Education Solutions

The Gerflor & Gradus ranges are both hygienic and safe, our solutions are suitable for all areas of the education facility.

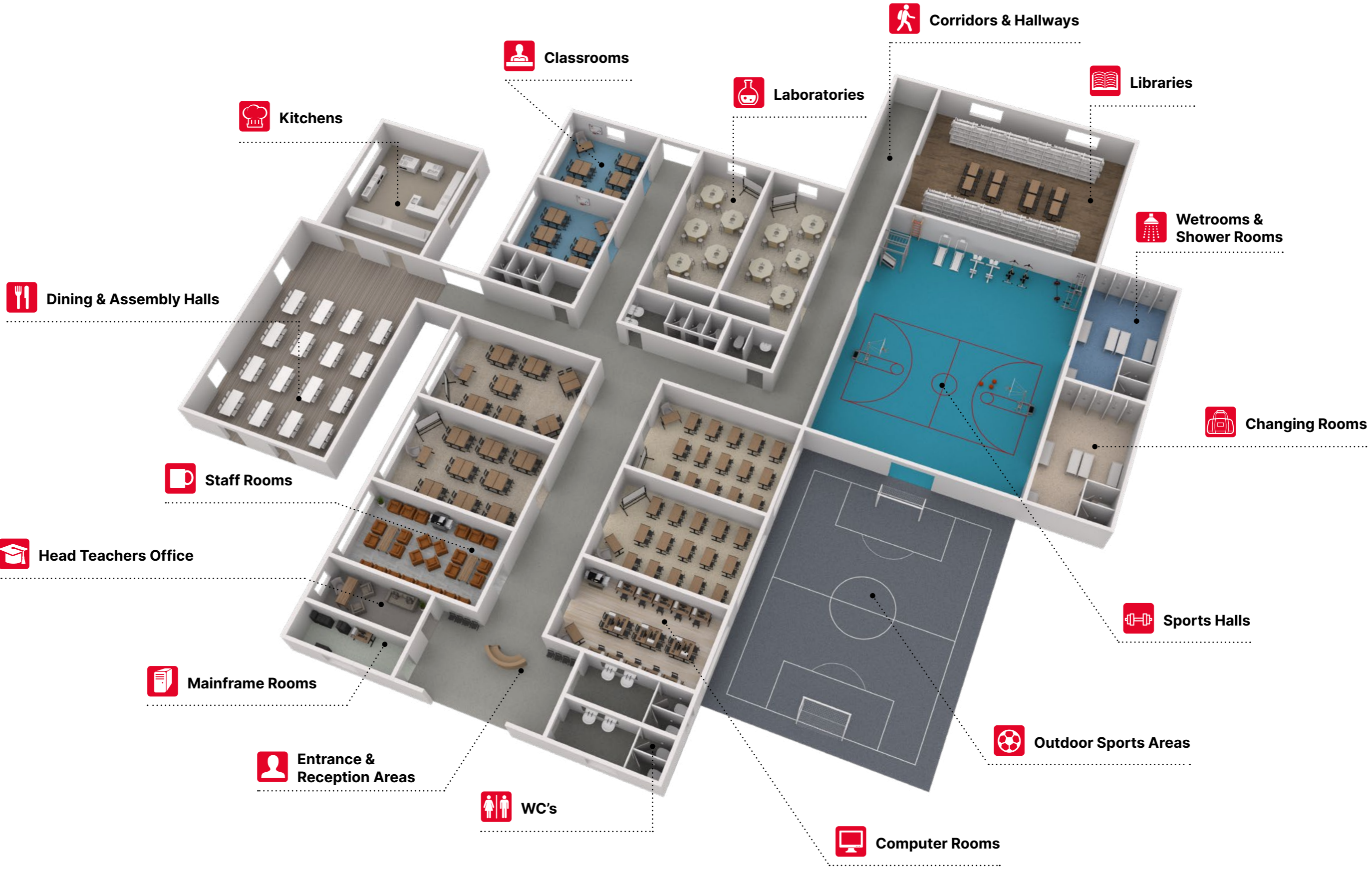

Entrance & Reception Areas

Key considerations when selecting Flooring and Wall Protection products for Entrance & Reception Areas

- ✔ A bright, calm and welcoming environment
- ✔ Resistance to heavy traffic
- ✔ Good slip resistance on floors
- ✔ Practical in design to facilitate building access
- ✔ Protecting walls and corners that are vulnerable to damage
- ✔ Zoning and navigation assistance

Options shown are a small selection, full colour range available on our website

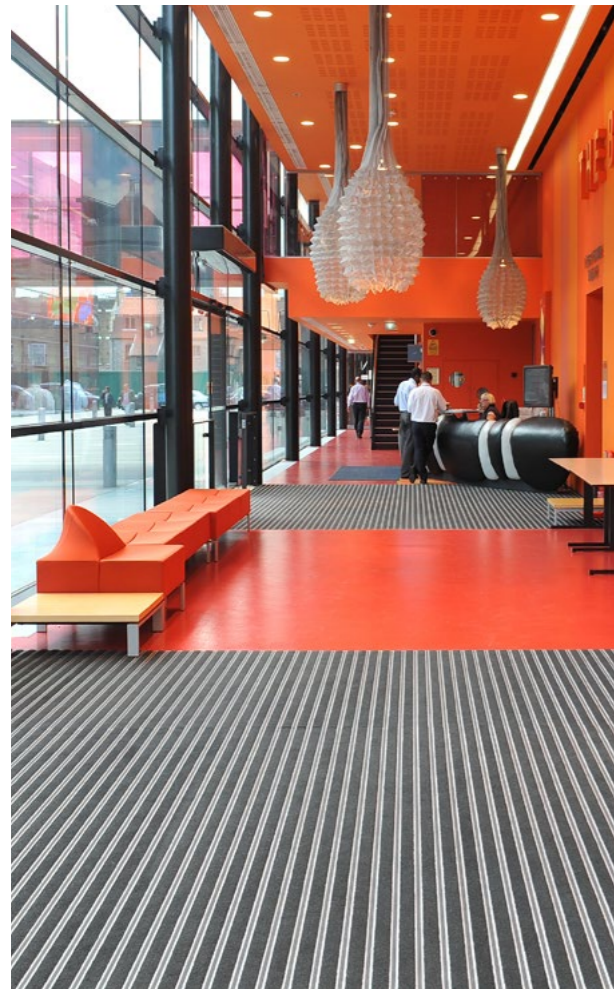

Stair Edgings - XT™ Aluminium

The Gradus XT range of stair edgings offers the ultimate solution in reducing slips, trips and falls on stairs.

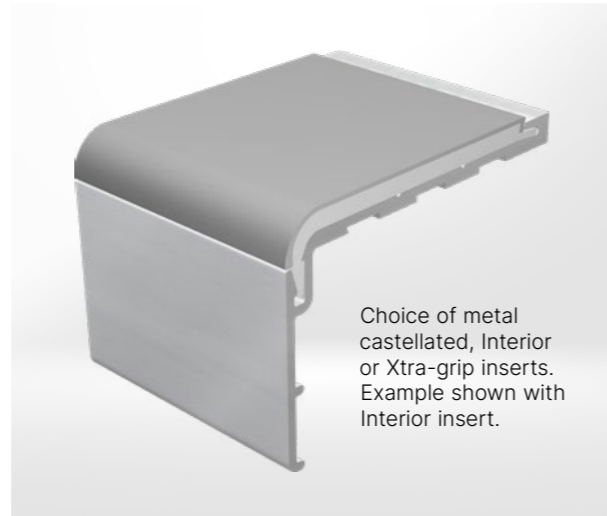

To see the full range - [click here](#)

Barrier Matting - Esplanade 5000/6000

Absorbs dirt and moisture in medium to heavy levels of foot and wheeled traffic. Available in a range of colours.



Boulevard 6000 Indigo Wiper
Dark Bronze Anodised Base



Boulevard 5000 Cuckoo Wiper
Light Bronze Anodised Base



Boulevard 5000 Jackdaw Wiper
Mid Bronze Anodised Base



Pvc Scraper Wiper
Aluminium Base

Esplanade 5000 - [click here](#)

Esplanade 6000 - [click here](#)

Resilient Flooring - Taralay Libertex

Innovative MAX3 3-layer system: combines durability, acoustics, ease of use and installation.



1430 Legend Grey
Y: 30.7



2247 Hossegor Latte
Y: 38.3

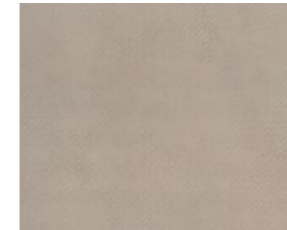

1785 Reflect Earth
Y: 32.0



2242 Legend Country
Y: 26.0

To see the full range - [click here](#)

LVT Flooring - Creation 70 Dryback LVT

A decorative flooring available in tile or plank. 0.7mm wear layer, ideal for high traffic areas.



0577 Albion
Y: 21.3



0535 Douglas
Y: 29.1

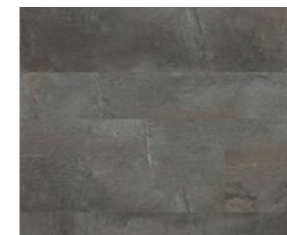

1069 Etna Dark
Y: 12.9

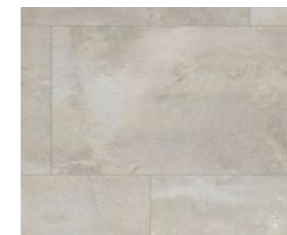

1068 Etna Beige
Y: 36.6

To see the full range - [click here](#)

Carpet Tiles - Lunar

Inspired by the lunar landscape the design is available in a choice of colourways to help create a stylish and modern environment.

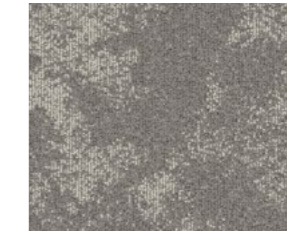

07402 Moretus
Y: 15.92

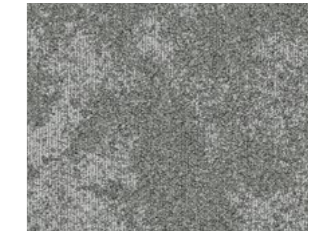

07406 Picard
Y: 11.68



07404 Stadium
Y: 5.59

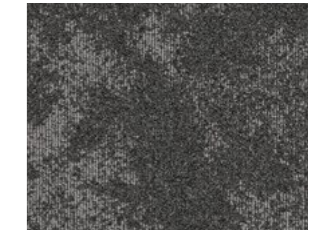

07405 Rook
Y: 5.55

To see the full range - [click here](#)

Wall Protection

Reception areas are often subject to scuffs and scrapes from chairs and other moveable objects. Corners and edges are also vulnerable from high levels of people and wheeled traffic.







- 1 SureProtect Artworx (print option)
- 2 Timber Handrail
- 3 SureProtect Design® (wood effect)
- 4 Standard PVC-u Corner Guard
- 5 Wall Strip

To see the full range - [click here](#)

Corridors & Hallways

Key considerations when selecting Flooring and Wall Protection for Corridors & Hallways

-  Selected products need to deal with heavy traffic both pedestrian and wheeled
-  Products should offer zoning and navigation assistance
-  Flooring must be slip resistant and be able to cope with heavy rolling loads
-  Robust Wall Protection system to protect vulnerable walls and corners
-  Handrails for guidance and support

Options shown are a small selection, full colour range available on our website



Resilient Flooring - Tarasafe Impression

Safety flooring that's HSE 36+ and R11 slip-resistant, available in wood effect and mineral designs.



1029 Rough Grey
Y: 31.6



0520 Noma Black
Y: 11.3

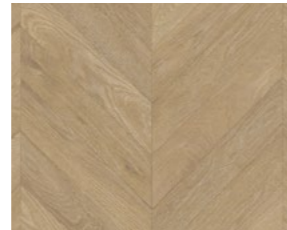

1110 Rivau Nature
Y: 25.5



0038 Pierre
Y: 32.9

To see the full range - [click here](#)

Resilient Flooring - DLW Colorette

Vivid colours to awaken any interior. Micro-scratch and stain resistance. Made from 98% natural materials.

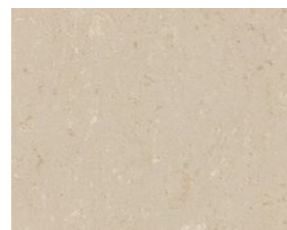

0012 Light Beige
Y: 40.2



0006 Vivid Green
Y: 24.9

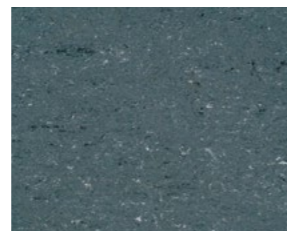

0080 Elephant Grey
Y: 13.5



0123 Poppy Blue
Y: 21.9

To see the full range - [click here](#)

Wall Protection - SureProtect Endure

Textured PVC-u sheet protects the wall and helps to conceal the effects of impact and abrasion.

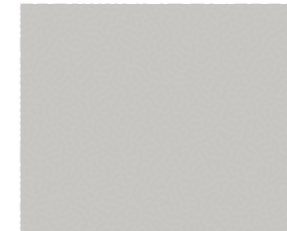

032 Flint
Y: 43.70

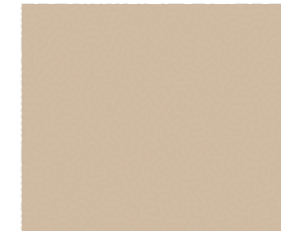

035 Hessian
Y: 35.79



045 Fern
Y: 18.23



041 Terracotta
Y: 27.04

To see the full range - [click here](#)

Wall Protection - Corner Guard

Ideal for protecting one of the most vulnerable parts of a building from damage caused by everyday traffic.

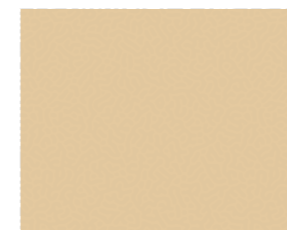

008 Sand
Y: 52.26



042 Mulberry
Y: 13.38

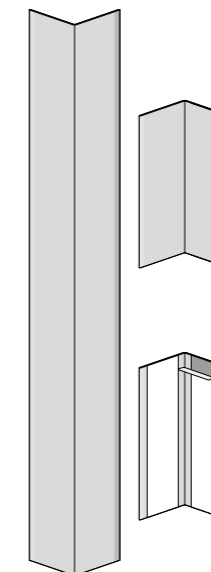

To see the full range - [click here](#)





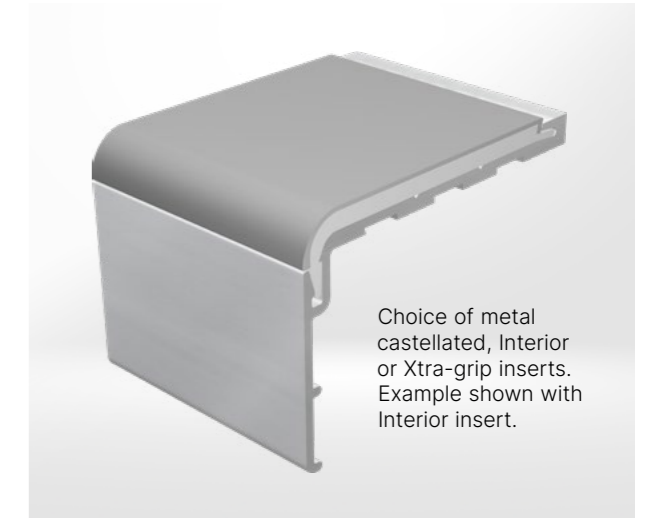

Stair Edgings - XT™ Aluminium

The Gradus XT range of stair edgings offers the ultimate solution in reducing slips, trips and falls on stairs.



To see the full range - [click here](#)

Key considerations when selecting Flooring and Wall Protection products for Sports Halls. Dedicated sport literature is also available.

-  Help reduce injuries from falls and impacts
-  Good underfoot performance to eliminate sprains and strains
-  Excellent resistance to rolling loads
-  Suitable for both sport and non-sport usage
-  Surface treatment to mean no long-term high maintenance costs
-  Protection for both child and adult users of the hall
-  Taraflex AE systems meet DfE guidelines

Options shown are a small selection, full colour range available on our website



Resilient Flooring - Taraflex® Multi-Use

81% natural or recycled P1 sports flooring that's suitable for all types of sports and leisure activities.

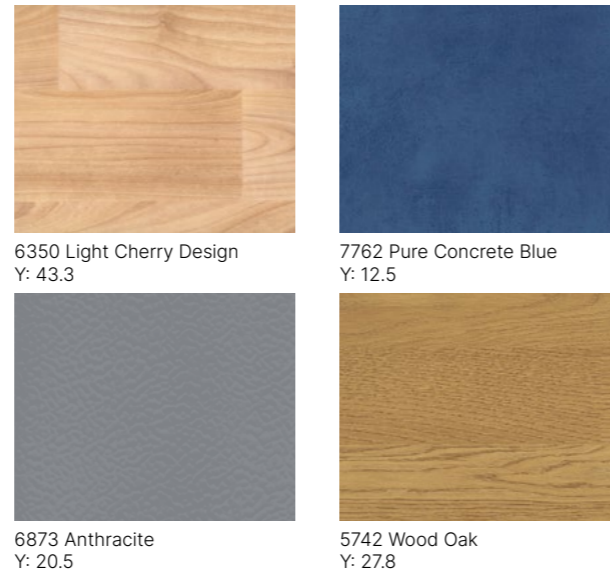

To see the full range - [click here](#)

Resilient Flooring - Taraflex® Evolution*

81% natural or recycled P1 sports flooring that's ideal for a variety of sports and leisure activities.

* Also available in Sustainable Looselay

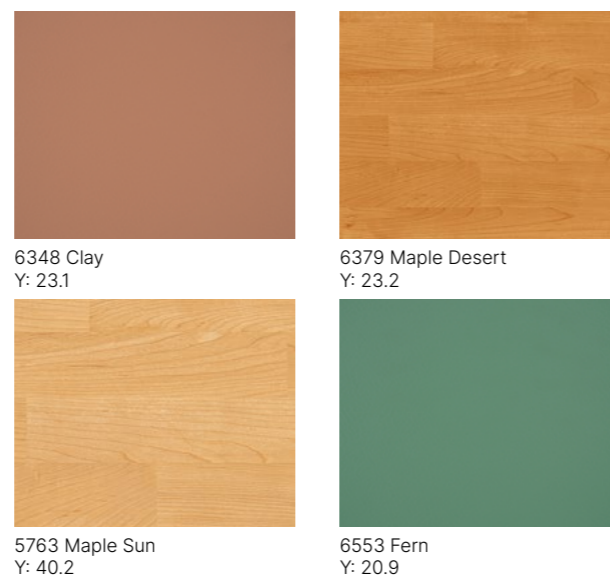

To see the full range - [click here](#)

Resilient Flooring - Taraflex® Systems

Available with a number of Taraflex finishes or DLW Linoleum to give either combined elastic or area elastic finish. Combined area elastic systems also give the benefit of impact protection and high levels of shock absorption.

All finishes with Gerflor systems benefit from surface treatments

Protacosol® on Taraflex® and Neocare™ on DLW products will offer optimised grip slide performance for players, while making the floor easy to maintain by eliminating intensive, long-term maintenance. The reduced whole life costs will be welcomed by all the stakeholders responsible for maintaining the sports floors.

Taraflex® Subflex AE

- > Ideal for installations requiring a low profile / renovation projects
- > EN 14904 complaint: category A3 with <40% force reduction
- > Meets DfE technical guidance

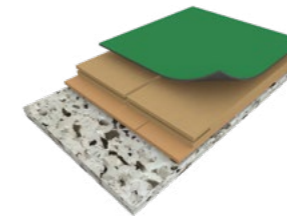

Taraflex® Subflex Combisport

- > Ideal for installations requiring a low profile / renovation projects



Taraflex® AE 85

- > Adjustable height for uneven subfloors
- > EN 14904 complaint: category A4 with <55% force reduction
- > Meets DfE technical guidance



Taraflex® Combisport 85

- > Ideal for installations with uneven subfloors



Wall Protection - SureProtect Endure

Textured PVC-u sheet protects the wall and helps to conceal the effects of impact and abrasion.

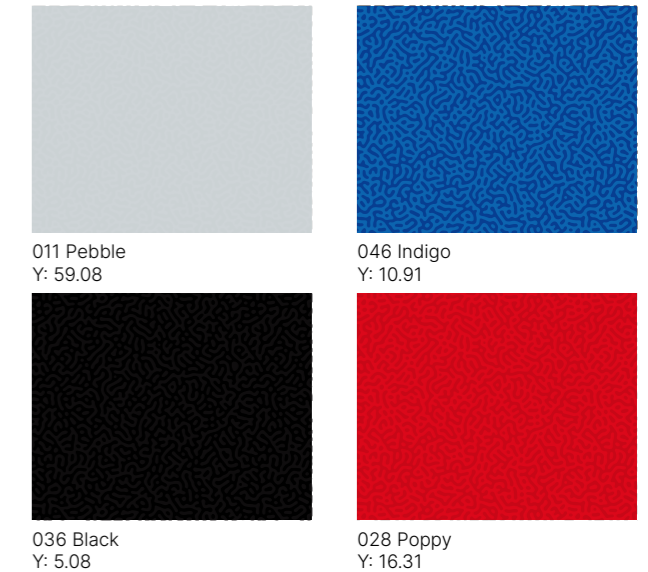

To see the full range - [click here](#)

Secondary Barrier Matting - Esplanade 5000/6000

Absorbs dirt and moisture in medium to heavy levels of foot and wheeled traffic. Available in a range of colours.

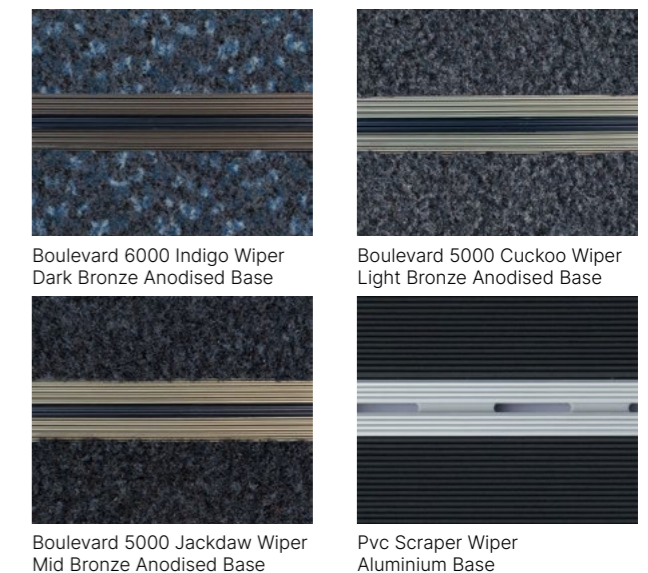

Esplanade 5000 - [click here](#)

Esplanade 6000 - [click here](#)

Key considerations when selecting Flooring and Wall Protection for Classrooms

- ✔ Provide a stimulating environment for pupils to learn
- ✔ Available in an extensive colour palette, numerous designs and offer high performance for everyday use
- ✔ Easy clean and low-cost maintenance
- ✔ Robust wall protection solution to protect the building from damage and improve safety for students
- ✔ Bespoke wall protection designs can help to create an inspirational learning environment

Options shown are a small selection, full colour range available on our website



Resilient Flooring - DLW Marmorette

Suitable for heavy-duty traffic and hardworking spaces. Manufactured from 98% natural materials and up to 40% recycled content.

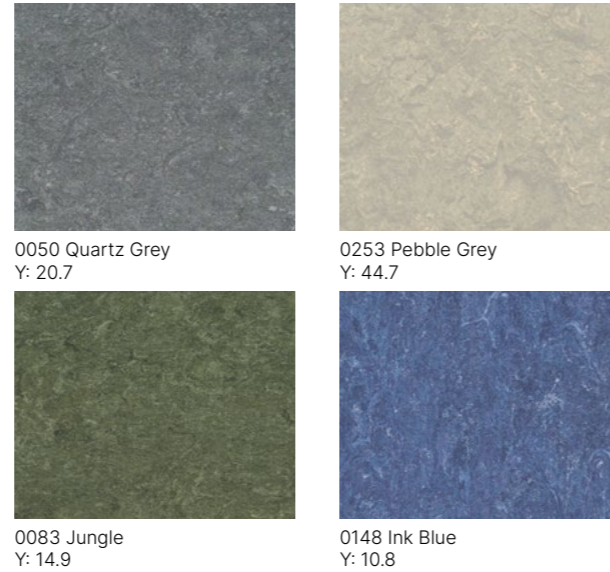

To see the full range - [click here](#)

Resilient Flooring - Tarasafe Impression

A tough, hygienic and durable safety flooring that offers HSE 36+ and R11 slip-resistance.

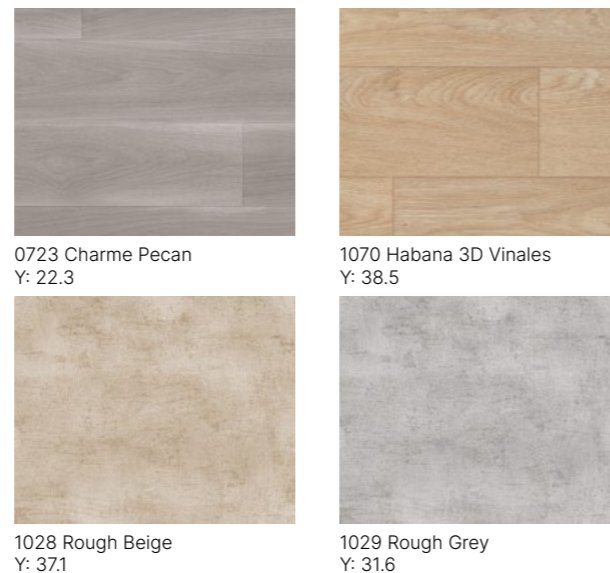

To see the full range - [click here](#)

Carpets - Stratus

Suitable for a wide variety of educational environments by combining durability, functionality and design.

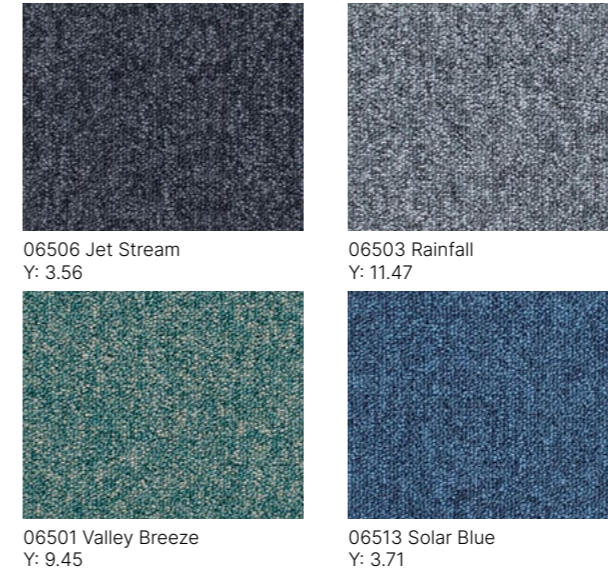

To see the full range - [click here](#)

Carpets - Lafite Connect

The range includes 3 patterns that can be used together to enhance an interior design.



To see the full range - [click here](#)

Wall Protection - SureProtect Endure

Textured PVC-u sheet protects the wall and helps to conceal the effects of impact and abrasion.

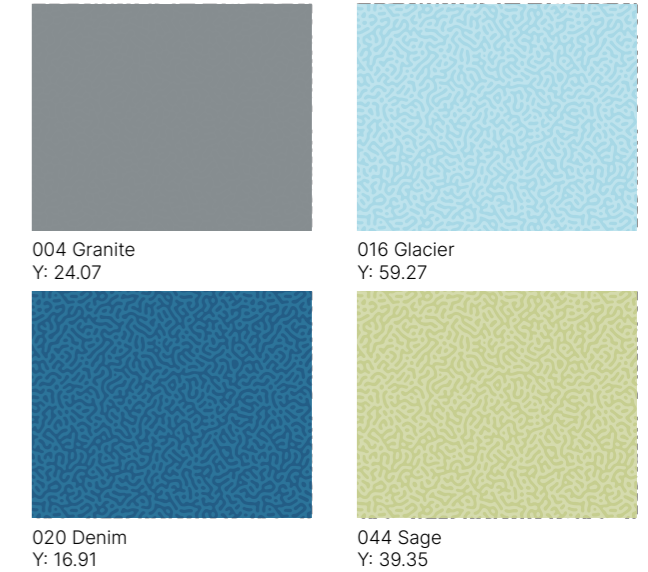

To see the full range - [click here](#)

Wall Protection - SureProtect Design

Wood-effect PVC-u wall cladding sheets that help create modern interiors whilst offering excellent surface protection.

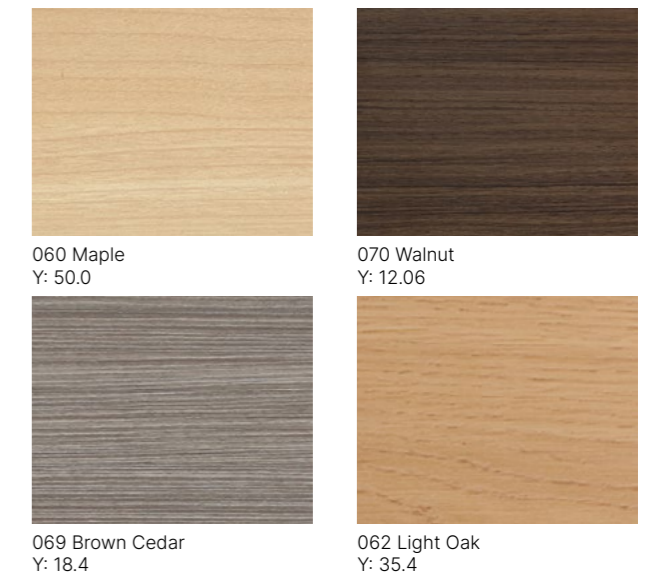

To see the full range - [click here](#)

Libraries

Key considerations when selecting Flooring and Wall Protection for Libraries

- ✓ A bright, calm and welcoming environment
- ✓ Resistance to heavy traffic
- ✓ Adequate sound reduction
- ✓ Practical in design to facilitate building access
- ✓ Protecting walls and corners that are vulnerable to damage
- ✓ Zoning and navigation assistance

Options shown are a small selection, full colour range available on our website

Wall Protection - SureProtect Design

Wood-effect PVC-u wall cladding sheets that help create modern interiors whilst offering excellent surface protection.

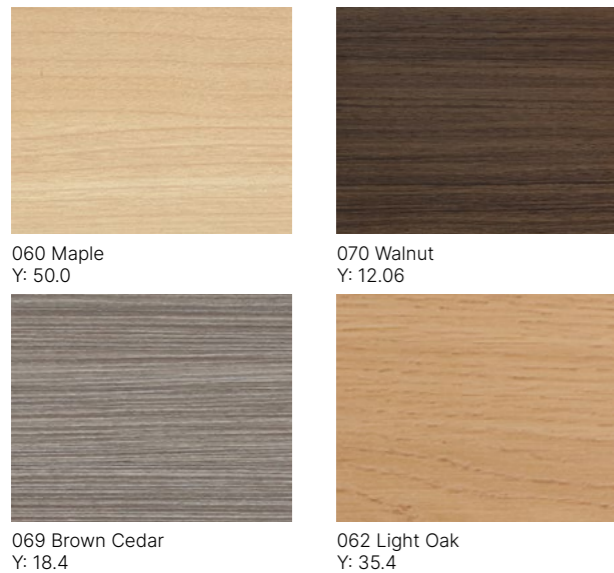

To see the full range - [click here](#)

Resilient Flooring - Taralay Impression Acoustic

A mix of vibrant colours and wood effect designs that provide 19db acoustic insulation for low impact sound.

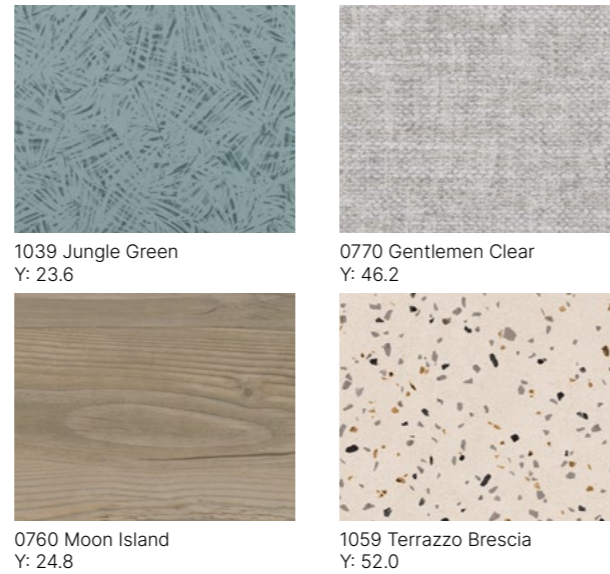

To see the full range - [click here](#)

Carpets Tiles - Times square

Unique design in 10 contemporary colours. Offering 32dB impact noise rating.

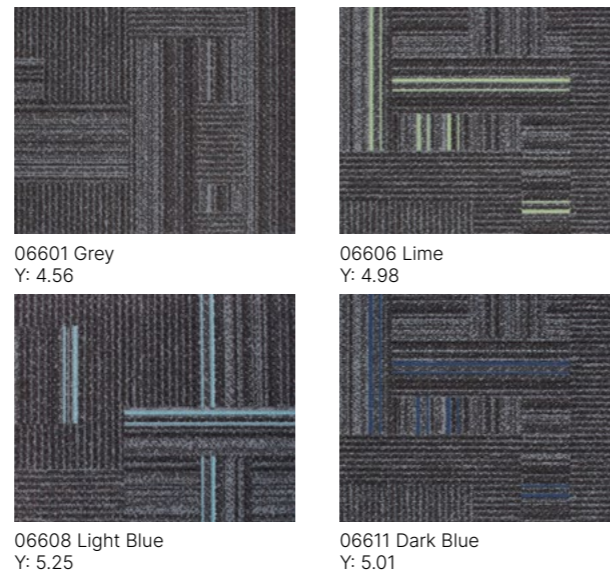

To see the full range - [click here](#)

Dining & Assembly Halls

Key considerations when selecting Flooring and Wall Protection for Dining and Assembly Halls

- ✓ Appealing and attractive
- ✓ Good slip resistance
- ✓ Scratch, dent and fade resistance
- ✓ Minimal maintenance for years
- ✓ Walls need to be hygienic and easy to clean
- ✓ Walls and corners need to be protected from scuffs and scrapes

Options shown are a small selection, full colour range available on our website

Wall Protection - SureProtect Pure

The smooth, easy-to-clean and maintain surface removes the need for grout which can harbour bacteria.

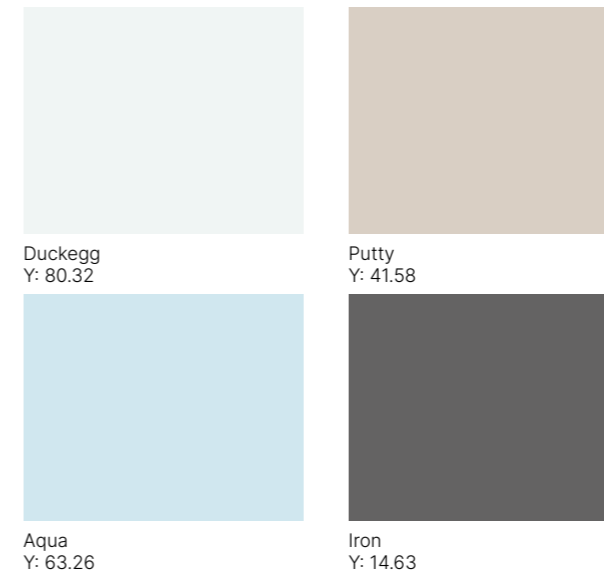

To see the full range - [click here](#)

Resilient Flooring - Tarasafe Standard

Outstanding safety flooring where slip-resistance, durability and hygienic conditions are required, meets +36 HSE guidelines.

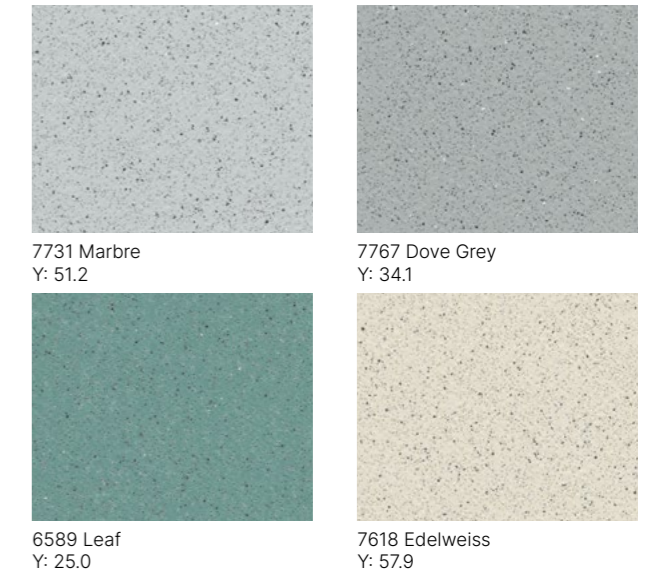

To see the full range - [click here](#)

Resilient Flooring - Tarasafe Impression

A tough, hygienic and durable safety flooring that offers HSE 36+ and R11 slip-resistance, available in wood effect and mineral designs.

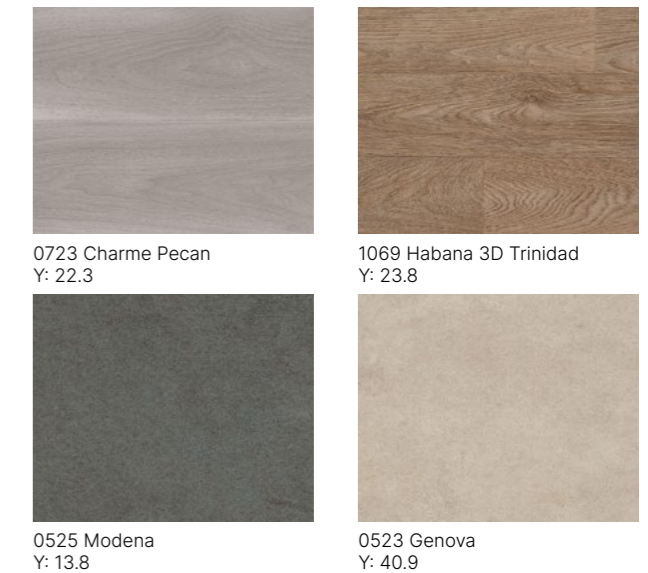

To see the full range - [click here](#)

Key considerations when selecting Flooring and Wall Protection for Kitchens

- ✔ Good slip resistance even when wet
- ✔ Resistance to heavy traffic and rolling loads
- ✔ Easy clean walls and low-cost maintenance
- ✔ Smooth and impervious walls to maintain food hygiene standards

Options shown are a small selection, full colour range available on our website

Resilient Flooring - Tarasafe Plus

A safety flooring with R10 slip resistance & meets +36 HSE guidelines. Available with a 12 year warranty.



7386 Savana
Y: 44



7767 Dove Grey
Y: 34.1



7731 Marbre
Y: 51.2

To see the full range - [click here](#)

Wall Protection - Wall Cladding – Stainless Steel Sheet

Robust, durable and heat resistant hygienic sheet ideal for commercial kitchens where surfaces are exposed to heat. Offered in 304 grade stainless steel in a satin finish.



K130/SPEC, Bespoke options

To see the full range - [click here](#)

Resilient Flooring - Tarasafe Super

A safety flooring with R12 slip resistance & meets +36 HSE guidelines. Available with a 12 year warranty for peace of mind.

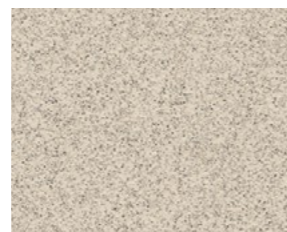

7386 Savana
Y: 44.0



7767 Dove Grey
Y: 34.1

To see the full range - [click here](#)

Key considerations when selecting Flooring and Wall Protection products for Toilets

- ✔ Good slip resistance even when wet
- ✔ Copes well with heavy traffic
- ✔ Provides good levels of hygiene
- ✔ Walls need to be smooth and easy to clean
- ✔ Walls need to have an impermeable barrier to moisture and bacteria

Options shown are a small selection, full colour range available on our website

Resilient Flooring - Tarasafe Standard

Outstanding safety flooring where slip-resistance, durability and hygienic conditions are required, meets +36 HSE guidelines.

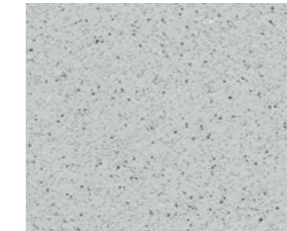

7731 Marbre
Y: 51.2

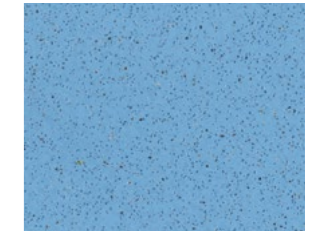

2430 Rain Drop
Y: 32.5

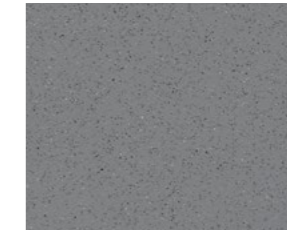

7773 Storm
Y: 21.3



8102 Paprika
Y: 21.9

To see the full range - [click here](#)

Wall Protection - SureProtect Pure

The smooth, easy-to-clean and maintain surface removes the need for grout which can harbour bacteria.

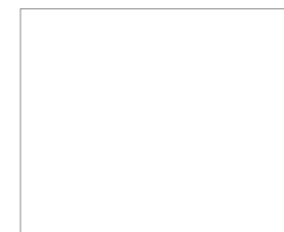

White
Y: 90.87

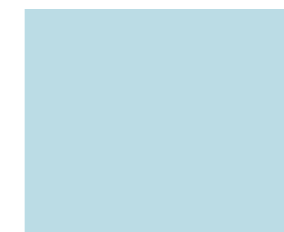

Iceberg
Y: 65.96

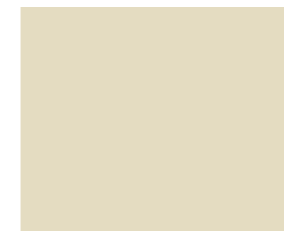

Champagne
Y: 41.58

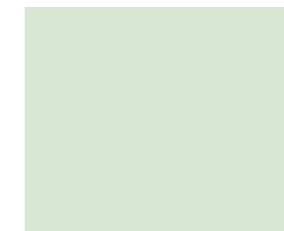

Peppermint
Y: 75.20

To see the full range - [click here](#)

Resilient Flooring - Tarasafe Ultra

Outstanding safety flooring where slip-resistance, durability and hygienic conditions are required, meets +36 HSE guidelines.

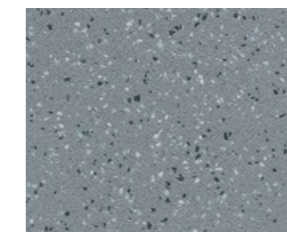

8709 Granite
Y: 25.4

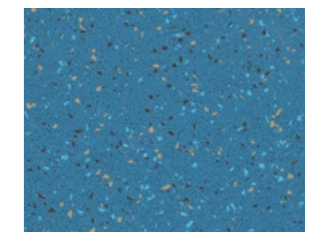

8420 Azurite
Y: 17.1

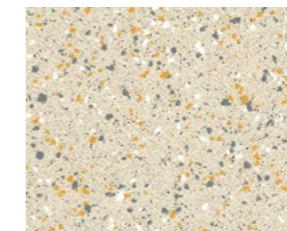

7383 Diopside
Y: 59.6



6593 Epidote
Y: 19.1

To see the full range - [click here](#)

Mainframe Rooms

Key considerations when selecting Flooring and Wall Protection products for Mainframe Rooms

- It's important for these specialised environments that flooring is both electro-conductive and fast to install with minimal interruption to activity during the school hours
- Flooring needs to be sensitive to electrostatic discharges
- Walls and corners need to be protected from scuffs and scrapes

Options shown are a small selection, full colour range available on our website

Resilient Flooring - Mipolam EL7

High-performance dissipative vinyl flooring treated with Evercare™ surface treatment for easy cleaning and maintenance.



4110 Violet Grey
Y: 46.3



4124 Smoked Opal
Y: 52.1

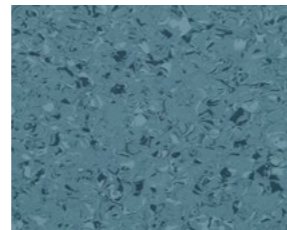

4166 Thistle
Y: 16.8



4132 Citrine
Y: 56.8

To see the full range - [click here](#)

Wall Protection - Wall Strip

Protecting walls against scuffs, scratches and abrasion caused by chairs, tables, and other moveable objects.



WST150N 150mm (h) no tape
WST150T 150mm (h) with tape



013 Greige
Y: 38.97



040 Lychee
Y: 44.83

To see the full range - [click here](#)

Resilient Flooring - GTI EL5

A unique solution offering all the benefits of a GTI Tile. Fast dove tail installation with electroconductivity and Evercare™ surface treatment.

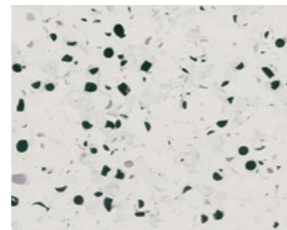

0350 Light Grey
Y: 58.2

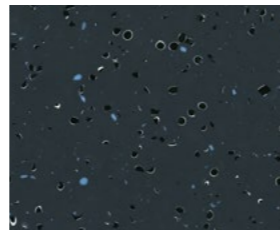

0351 Black
Y: 7

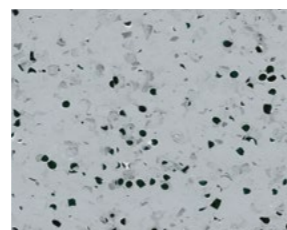

0352 Grey
Y: 35.5

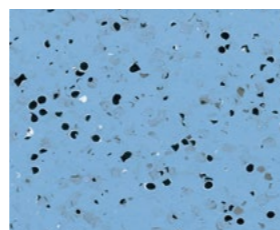

0354 Blue
Y: 33.4

To see the full range - [click here](#)

Head Teachers Office

Key considerations when selecting Flooring and Wall Protection for Head Teacher Offices

- Fast track solutions available for a luxurious look
- Minimises dust allergies
- Resistance to stains
- Quiet and comfortable underfoot
- Easy clean and low maintenance
- Wall cladding can be used to create a stylish environment
- Walls and corners need to be protected from scuffs and scrapes

Options shown are a small selection, full colour range available on our website

Resilient Flooring - Creation 55 LVT

Exclusive construction reinforced with fibreglass for comfort and stability. Exclusive wood and mineral designs.



0584 White Lime
Y: 36.0

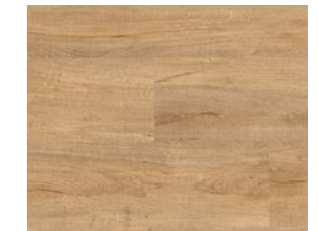

0796 Swiss Oak Golden
Y: 25.8



1268 Fabrik Mix Jute
Y: 26.3



0869 Bloom Uni Grey
Y: 23.2

To see the full range - [click here](#)

Wall Protection - SureProtect Design

Wood-effect PVC-u wall cladding sheets that help create modern interiors whilst offering excellent surface protection.



060 Maple
Y: 50.0

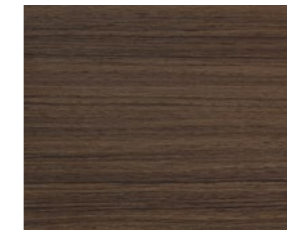

070 Walnut
Y: 12.06



069 Brown Cedar
Y: 18.4

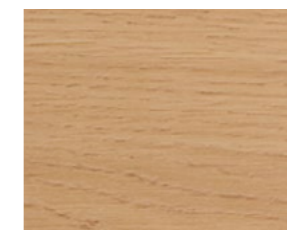

062 Light Oak
Y: 35.4

To see the full range - [click here](#)

Carpets - Urban Myth

Ideal for creating transitions to design a coordinated floor scheme. Features a linear design in a choice of colourways.

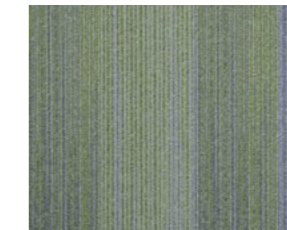

07309 Peridot
Y: 12.17

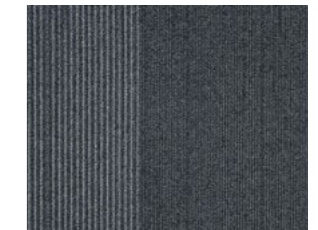

07304 Lead
Y: 7.72



07303 Steel
Y: 8.56

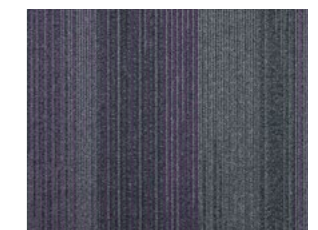

07311 Amethyst
Y: 8.51

To see the full range - [click here](#)

Computer Rooms

Key considerations when selecting Flooring and Wall Protection for Computer Rooms

- ✓ Anti-static dissipative
- ✓ Easy cleaning
- ✓ Noise reduction
- ✓ Walls and corners need protecting from scuffs and scrapes caused by tables and chairs and general movement of students

Options shown are a small selection, full colour range available on our website

Wall Protection - SureProtect Endure

Textured PVC-u sheet protects the wall and helps to conceal the effects of impact and abrasion.



018 Azure
Y: 45.14

048 Lagoon
Y: 48.61



006 Ivory
Y: 81.98

011 Pebble
Y: 59.08

To see the full range - [click here](#)

Resilient Flooring - Mipolam EL7

Anti-static dissipative performance flooring is available in a palette of 6 semi-directional designs.



0013 Pewter
Y: 18.2

0003 Ivory
Y: 56.1

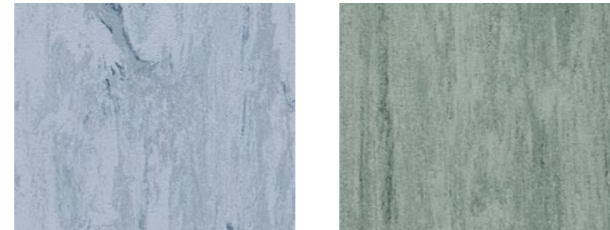

0112 Storm
Y: 35.3

0306 Green
Y: 28.9

To see the full range - [click here](#)

Resilient Flooring - Mipolam EL5

Permanent conductive flooring is available in a palette of 6 colours in a non-directional design.

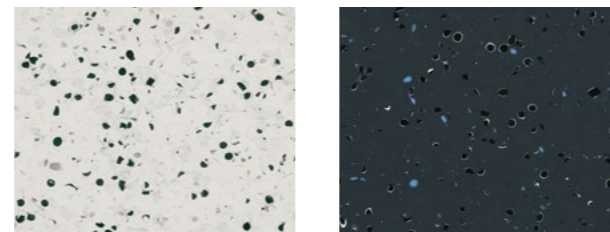

0350 Light Grey
Y: 58.2

0351 Black
Y: 7

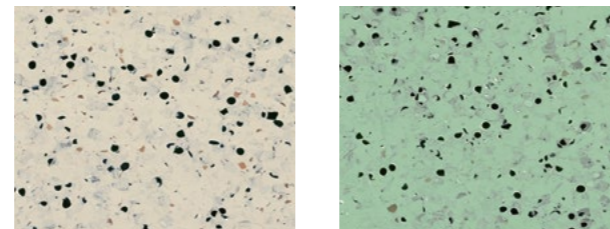

0353 Beige
Y: 48.4

0355 Green
Y: 36.7

To see the full range - [click here](#)

Outdoor Sports Areas

Key considerations when selecting Flooring and Wall Protection for Outdoor Sports Areas

- ✓ Improve player comfort in comparison to asphalt or concrete
- ✓ New courts can be built, in an existing space
- ✓ Retrofitted or portable courts for a tournament or an event
- ✓ Can be quickly and cost effectively installed
- ✓ Gerflor has a solution which does not require a yearly or costly refinish
- ✓ Handrails can be placed where pedestrian areas and walkways are adjacent to vehicle routes e.g. car parks

Options shown are a small selection, full colour range available on our website

Safety & Protection Systems

A modular handrail system consisting of galvanised steel rails and cast steel accessories. It is ideal for use in environments where pedestrian areas and walkways are adjacent to vehicle routes, for example, car parks, service areas and loading bays.

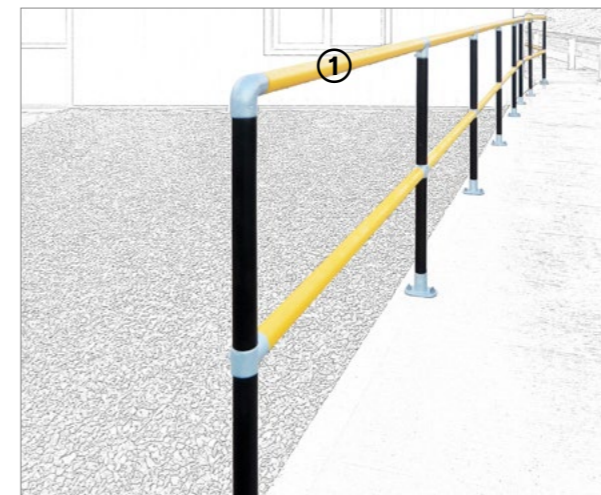

1 Handrail System

To see the full range - [click here](#)

Resilient Flooring - Sport Court® PowerGame™ Plus

PowerGame™ Plus tiles are safe to play on and can also be easily installed in all facilities. Build a new court, renovate an existing space or set up portable courts for a tournament or event. Designed for a wide variety of sports, this solution is an ideal outdoor playing surface for virtually any activity.



0003 Black

0005 Bright Blue

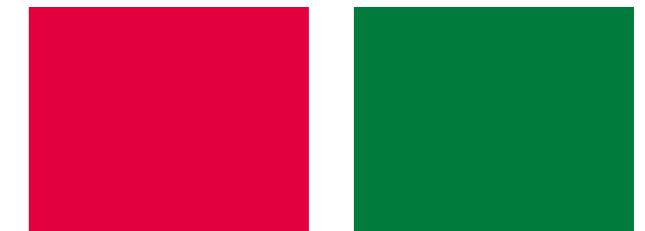

0006 Bright Red

0014 Green

To see the full range - [click here](#)

Staff Rooms

Key considerations when selecting Flooring and Wall Protection for Staff Rooms

- ✓ Stylish flooring can instantly transform a clinical looking staff room
- ✓ Easy to clean walls and floors
- ✓ Resistance to stains and cleaning chemicals
- ✓ Walls and corners need to be protected against minor scuffs and scrapes
- ✓ Bespoke artwork on the wall can create and inspirational working environment

Options shown are a small selection, full colour range available on our website

Wall Protection - SureProtect Artworx

Wall protection can be utilised to create a stimulating and vibrant space by using contemporary design themes.



K130/SPEC, Bespoke options

To see the full range - [click here](#)

Resilient Flooring - Taralay Premium Comfort

Acoustic and shock absorption properties with high acoustic performance and safe underfoot cushioning.

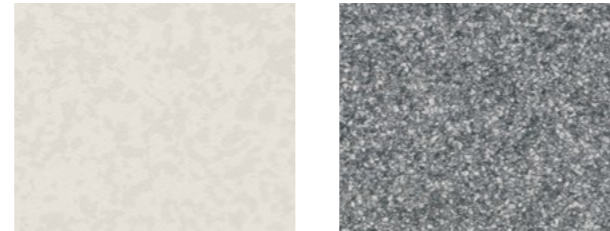

4364 Ivory New
Y: 61.1

9745 Cosmic
Y: 28.4

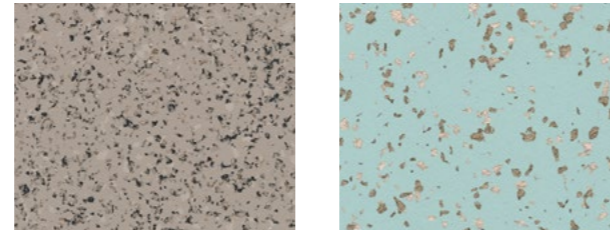

2744 Queens Soft
Y: 29.4

8621 Ode
Y: 50.0

To see the full range - [click here](#)

Carpets - Lafite Connect

Combine patterns within the Lafite Connect range to create unique designs ideal for large spaces or feature areas.

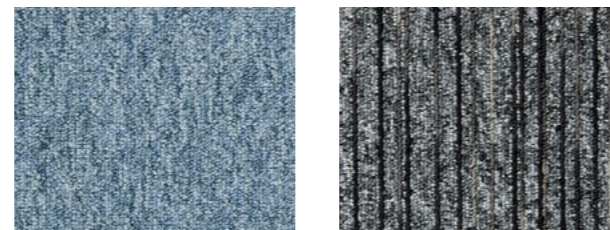

Lafite Plains LC6
Y: 12.45

Lafite Space LCSPACE28
Y: 10.24

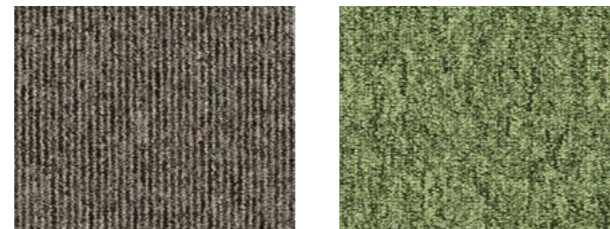

Lafite Stripes LCS18
Y: 8.16

Lafite Plains LC5
Y: 10.99

To see the full range - [click here](#)

Wet Rooms & Shower Rooms

Key considerations when selecting Flooring and Wall Protection for Wet Rooms

- ✓ Good slip resistance
- ✓ Watertight floors and walls
- ✓ Resistance to stains and chemicals
- ✓ Easy clean and low-cost maintenance
- ✓ Walls need to be smooth and easy to clean creating and impermeable barrier to moisture and bacteria

Options shown are a small selection, full colour range available on our website

Wall Protection - SureProtect Pure

The smooth, easy-to-clean and maintain surface removes the need for grout which can harbour bacteria.



Iceberg
Y: 65.96

Duckegg
Y: 80.32

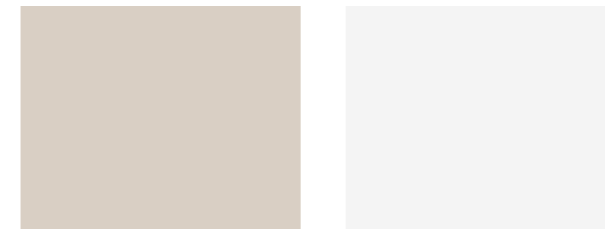

Putty
Y: 41.58

Porcelain
Y: 73.28

To see the full range - [click here](#)

Resilient Flooring - Tarasafe H2O

Stud-free high-performance slip resistant safety flooring for wet and dry, barefoot and shod applications, meets +36 HSE guidelines.

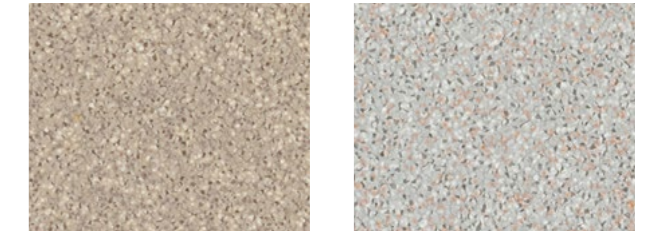

0031 Eacham
Y: 34.3

0024 Peyto
Y: 43.7

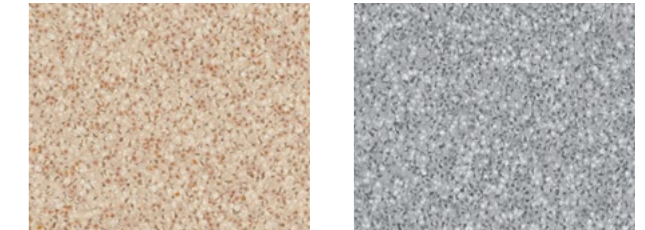

0025 Nile
Y: 43.4

0033 Rhine
Y: 29.7



0034 Zambezi
Y: 19.9

0032 Malawi
Y: 40.1

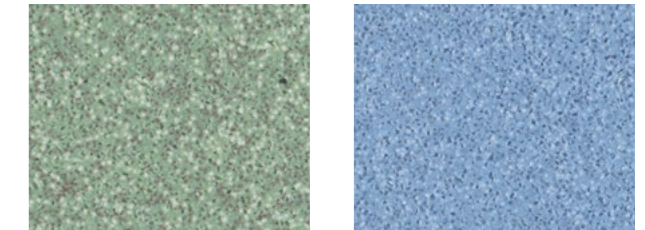

0035 Bacalar
Y: 32.5

0036 Lagoa
Y: 31.1

To see the full range - [click here](#)

Laboratories

Key considerations when selecting Flooring and Wall Protection for Laboratories

- ✓ Hygiene and infection control
- ✓ Resistance to stains and chemicals
- ✓ Good slip resistance
- ✓ Quiet and comfortable underfoot
- ✓ Easy clean and low-cost maintenance

Options shown are a small selection, full colour range available on our website

Resilient Flooring - Mipolam Affinity

High-performance flooring with good abrasion resistance & Evercare™ surface treatment for easy cleaning.



4412 Tundra



4402 Yuki

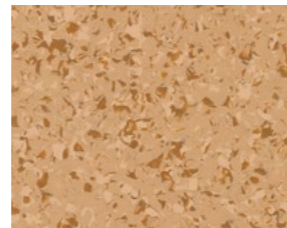

4425 Amber

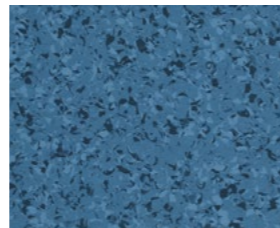

4436 Santorini

To see the full range - [click here](#)

Wall Protection - SureProtect Pure

The smooth, easy-to-clean and maintain surface removes the need for grout which can harbour bacteria.

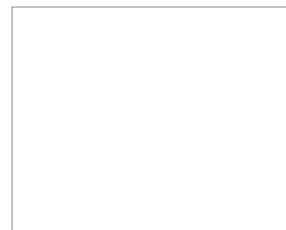

White
Y: 90.87

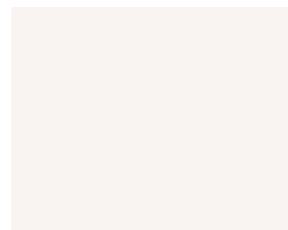

Cotton
Y: 82.91

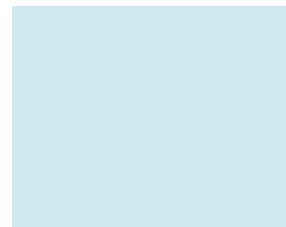

Aqua
Y: 63.26

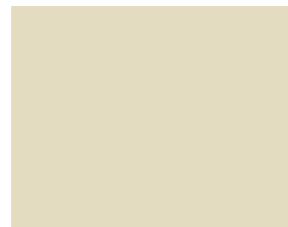

Champagne
Y: 72.74

To see the full range - [click here](#)

Resilient Flooring - Mipolam Symbioz™

High-performance homogeneous flooring treated with Evercare™ for outstanding chemical and stain resistance.

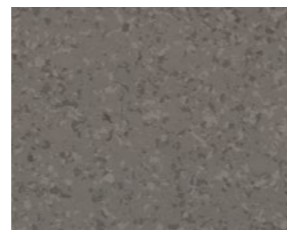

6044 Sea Storm

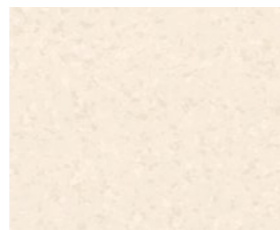

6001 Cotton

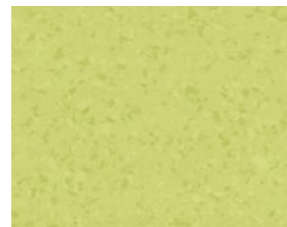

6027 Acacia



6032 Sunshine

To see the full range - [click here](#)

Changing Rooms

Key considerations when selecting Flooring and Wall Protection for Changing Rooms

- ✓ 2 options available that all meet HSE +36 guidelines
- ✓ Good slip resistance even when wet
- ✓ Copes well with heavy traffic and provides good levels of hygiene
- ✓ Walls need to be hygienic and easy to clean
- ✓ Corners are vulnerable to damage so need protecting

Options shown are a small selection, full colour range available on our website

Resilient Flooring - Tarasafe Standard

Outstanding safety flooring where slip-resistance, durability and hygienic conditions are required, meets +36 HSE guidelines.



6245 Atoll
Y: 41.1

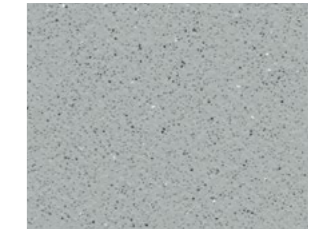

7767 Dove Grey
Y: 34.1



6084 Badian
Y: 20.9



7386 Savana
Y: 44.3

To see the full range - [click here](#)

Wall Protection - SureProtect Pure

The smooth, easy-to-clean and maintain surface removes the need for grout which can harbour bacteria.



Iron
Y: 14.63

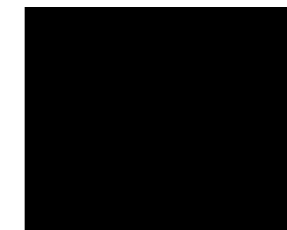

Onyx
Y: 4.96

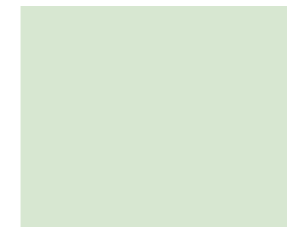

Peppermint
Y: 75.20



Putty
Y: 41.58

To see the full range - [click here](#)

Resilient Flooring - Tarasafe Ultra

Outstanding safety flooring where slip-resistance, durability and hygienic conditions are required, meets +36 HSE guidelines.

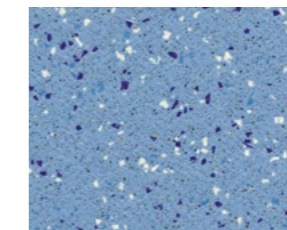

7482 Halite
Y: 31.8

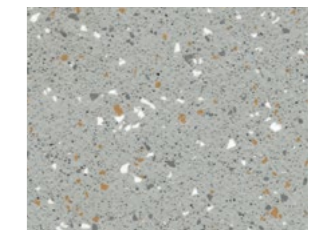

8704 Pebble
Y: 44.1



6348 Clay
Y: 38.7

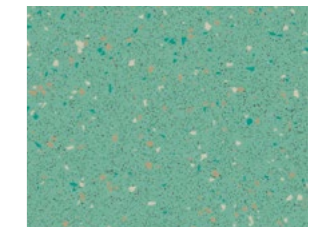

8592 Aventurine
Y: 32.6

To see the full range - [click here](#)

A selection of our case studies



Client: Carronrange School
Solution: Tarasafe Impression, Tarasafe Ultra, Tarasafe Ultra H2O, GTI MAX and Mipolam SD



Client: Park Mains High School
Solution: DLW Linoleum Range



Client: St Ninians High School, Scotland
Solution: CGS5090T Standard Corner Guards, SureProtect Endure® Wall Cladding



Client: Institute of Veterinary Science - University of Liverpool, Leahurst Campus
Solution: WGS200F Wall Guards, Standard PVC-u Corner Guards



Client: Watford Grammar School for Boys
Solution: Taralay Premium Comfort and Mipolam



Client: Torquay Boys Grammar School
Solution: Taraflex® Performance Vinyl Sports Flooring

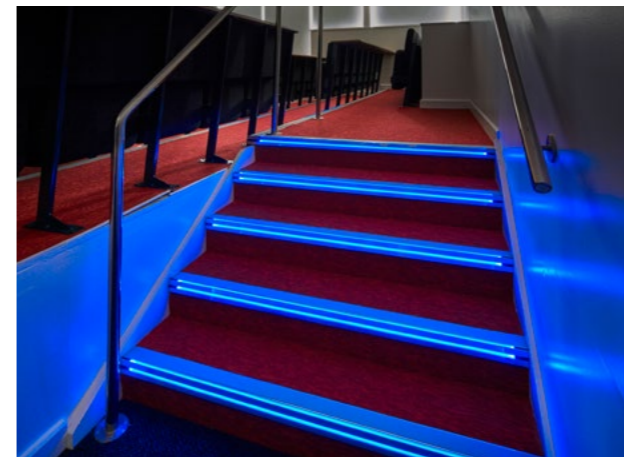

Client: University of Bath
Solution: ATF71L Illuminated Stair Edgings with Continuity LED Lighting Systems in Blue



Client: Nottingham Free School
Solution: SureProtect Endure Wall Cladding, Surface Mount Standard PVC-u Tape on Corner Guards



Client: The Priory Ruskin Academy, Grantham
Solution: SureProtect Endure® Wall Cladding at half height, CGS2590 Standard Corner Guards



Client: Bitterne Park School
Solution: SureProtect Pure® Wall Cladding, Stainless Steel Corner Guards



Client: The University of Manchester
Solution: RNT718L Clear PVC-u Stair Edgings with Continuity LED Lighting in Green, Standard Interior Insert, Colour: Glacier



Client: Confetti X, Nottingham
Solution: ATD121L - Aluminium Step Profile with a 5w Warm White LED Tape, Gradus Grip GG290

Innovation, Service & Design

Surface Treatment & Cleaning

Resilient flooring surface treatments can be incredibly beneficial in education environments, where cleanliness and hygiene are of the utmost importance. Gerflor Evercare, ProtecSol2, Neocare, PUR, Sparclean, ProtecSol Control and ProtecShield use antimicrobial agents in the resilient flooring, which can inhibit the growth of bacteria and other micro-organisms.

This helps to create a cleaner and healthier environment for students and staff.

Additionally, these coatings make resilient flooring easier to clean, reducing the risk of cross contamination and the spread of diseases. Surface treatments also provide slip-resistance, which can help to prevent falls and injuries. This is important in areas where spills are common, such as dining halls, changing rooms and corridors.

Evercare™ | ProtecSol®2 | Neocare™ | PUR | SparClean® | ProtecSol® Control | ProtecShield™



Supply & Fit

Gradus' wall protection supply and fit service provides a comprehensive solution for safeguarding walls in education buildings. The service includes the supply and installation of corner guards, crash rails, and wall cladding, designed to withstand impact and abrasion, reducing the need for repairs and maintenance. The products come in various materials, finishes, and colours, allowing for customisation to suit any interior design scheme. With a team of experienced installers, Gradus ensures products are fitted to the highest standards, providing maximum protection and a seamless finish. The expert advice and guidance supports customers to choose the right products for their specific needs, ensuring compliance with safety requirements and building regulations.

Colour Contrast

Colour contrast and light reflectance value (LRV) are essential considerations when it comes to achieving building standards in the UK and promoting inclusive design. Colour contrast refers to the difference in colour between two adjacent surfaces, while LRV measures the amount of light a surface reflects. By using either high-contrast colours and LRVs that meet the recommended standards (30 points difference between floors and walls) or similar tonal colours (8-point difference between adjoining floor coverings), designers can create spaces that are safer and more accessible for all users. For example these factors can significantly impact how people with visual impairments navigate and perceive spaces. This approach can also help buildings meet legal requirements for accessibility, such as those outlined in the Disability Discrimination Act (DDA) and Building Regulations Part M.





Gerflor teams have always considered customers and the environment as their absolute priorities. Our floor coverings, wall solutions and finishing components are user friendly, sustainable solutions. They are designed with respect for our planet to last as long as possible with proposed end-of-life options. From product design through to end-of-life, the circular economy is a core priority for the group. We have set out key commitments to guide our environmental management up to 2025.



GRADUS

At Gradus, we care deeply about our planet and our role in its future. We are committed to reducing our environmental footprint and enhancing our positive impact. By 2025, we aim to achieve ambitious targets which include reducing carbon emissions, wastage and usage. We are also committed to boosting recycling and moving into green energy. In addition we are working with local communities by giving back to society and local causes.



Interactive Education Brochure

To request a hard copy of the Education Sector Brochure or anything else call 01625 428922 or email contractuk@gerflor.com or imail@gradus.com.



Gerflor[®]

GRADUS

Head Office:

Park Green,
Macclesfield,
Cheshire, SK11 7LZ

Gerflor enquiries

Tel: [01625 428922](tel:01625428922)
E-mail: contractuk@gerflor.com
Website: gerflor.co.uk

Gradus enquiries

Tel: [01625 428922](tel:01625428922)
E-mail: imail@gradus.com
Website: gradus.com